

**PACSETER PLUS**  
**VARIABLE SPEED DC DRIVE**  
**Pt # 910-3522-024**

OPERATIONS MANUAL

REVISION 4.0  
JUNE 2002

# Table of contents

---

## SECTION ONE

INTRODUCTION.....	1
CONTROL FEATURES.....	2
WARRANTY.....	3
SAFETY.....	4
Q.C. TESTING.....	5
STORAGE.....	5

## SECTION TWO

GENERAL DESCRIPTION.....	6
SYSTEM REQUIREMENTS.....	6
CONTROL SPECIFICATIONS.....	7

## SECTION THREE

CURRENT LIMIT/TEMPERATURE FOLDBACK..	8
UNDER VOLTAGE LOCKOUT.....	8
HIGH PEDAL DISABLE.....	8
ACCEL AND DECEL RATES.....	9
POTENTIOMETER SCALING.....	9
REVERSE SPEED LIMIT.....	10
BRAKE TIMER AND DRIVER.....	10
CONTROL INHIBIT.....	11
THROTTLE CENTER ADJUSTMENT.....	11
SINGLE ENDED THROTTLE OPTION.....	11
POT LOSS PROTECTION.....	12
POT OUT OF RANGE PROTECTION.....	12
REVERSE POLARITY PROTECTION.....	12
ANTI-PLUG CIRCUITRY.....	13
FOUR QUADRANT OPERATION.....	13
ANTI-ROLLBACK.....	13

# Table of contents (continued)

---

## **SECTION FOUR**

ENCLOSURE CONSIDERATIONS.....	14
POWER WIRING.....	15
SIGNAL WIRING.....	15
TERMINAL DESCRIPTIONS.....	16
TYPICAL CONNECTION DIAGRAM.....	18

## **SECTION FIVE**

GENERAL CONSIDERATIONS.....	19
SPEED RANGE REDUCTION POT.....	20
SET-UP PROCEDURE.....	21

## **SECTION SIX**

TROUBLESHOOTING.....	24
----------------------	----

# Section One

## Introduction

---

This manual provides the information you will need in order to properly install, operate and troubleshoot the **PACESETTER Plus** variable speed DC drive.

Improvements over the previous design include:















- Increased current capacity. Up to 35 Amps under normal operation (70 Amps peak when cool).
- New temperature sensing circuitry that proportionately reduces the current to protect the output devices during extended high-current demand.
- Current limited Brake Driver allows connection to low impedances without controller damage.
- Control circuitry has been redesigned to assure consistent performance by automatically compensating for differences in throttle potentiometers.
- Latching High Pedal Disable circuitry prevents unexpected movement of the vehicle if the throttle is activated before the on/off switch is activated.
- Single ended throttle pot configurable. Can be configured on special order to accept a single ended throttle potentiometer and a forward/reverse switch.

The improved **PACESETTER Plus** has been designed as a drop-in replacement for the previous model. All input and output connections are identical in their functions and locations.

Please read this manual completely before attempting to install or operate your new control.

# Control Features

---

-  High efficiency MOSFET design, reduces motor and battery losses while providing silent operation.
-  Advanced proportional temperature sense circuitry provides extended current operation (up to 70 Amps peak).
-  Current limited brake driver protects controller against low impedance brakes.
-  Simple installation. No adjustments required on standard unit.
-  Latching high pedal disable circuitry, protects against unexpected vehicle movement.
-  Reverse polarity protection on power connections.
-  Anti-rollback circuitry modifies brake response, minimizing rollback.
-  Reduced reverse speed adjustment available on board.
-  Pot-loss circuitry disables control if a pot connection is broken.
-  Out of range circuitry disables control if throttle signal extends past a safe operating range.
-  Undervoltage protection prevents unsafe operation when batteries are low.
-  Single ended throttle option available on special order, allows single ended throttle configurations with Fwd/Rvs switching.
-  Inhibit mode allows battery charger connection without disconnecting power connections.
-  Four-Quadrant operation, provides true regenerative operation for braking and speed control.
-  Fast-On .250" spade connectors for simple interfacing.

# Warranty

---

**DES** warrants this equipment to be free from defects in material and workmanship for a period of one (1) year from the date of shipment. If, within the warranty period, any such equipment is proved to the satisfaction of **DES** to be defective and the Buyer promptly notified **DES** in writing as soon as the defect occurred, such equipment will be repaired or replaced at the discretion of **DES**. Sufficient time will be allowed for the manufacture of replacement materials. Authorization and shipping instructions for return of products or parts must be obtained by the Buyer in advance of doing so. The foregoing warranty does not cover reimbursement for transportation, removal, installation or other expenses which may be incurred in connection with repair or replacement.

This warranty shall not apply (a) to equipment not manufactured by **DES**, (b) to equipment which has been repaired or altered by others than **DES** so as in **DES**'s judgement, to affect the same adversely (c) to equipment which has been subject to negligence, accident or damaged by circumstances beyond the control of **DES**, or (d) to equipment which has been misapplied, overloaded, abused or subjected to abnormal conditions or temperature, dirt or corrosive matter. With respect to equipment sold but not manufactured by **DES**, the warranty obligations of **DES** shall in all respects conform and be limited to the warranty actually extended to **DES** by its supplier. **DES** will not be liable for any expenses or liability for any repairs made outside of **DES** by other than **DES** personnel without **DES**'s written consent.

**DES** does not warrant that its products are suitable for any particular application. The Buyer assumes the responsibility for determining the product's suitability for the application and for testing the prototype units. **DES**'s responsibility is limited to providing production quantities which will, within normal production tolerance, be in accordance with the performance and specification mutually agreed upon and approved by the Buyer.

## Warranty (continued)

---

THE FOREGOING CONSTITUTES THE SOLE AND EXCLUSIVE REMEDY OF THE BUYER AND THE SOLE OBLIGATION OF **DES**, AND IS IN LIEU OF ANY AND ALL OTHER WARRANTIES, EXPRESSED, IMPLIED OR STATUTORY OR OTHERWISE, THE IMPLIED WARRANTIES OF MERCHANTABILITY AND FITNESS FOR A PARTICULAR PURPOSE ARE SPECIFICALLY DISCLAIMED. IN NO EVENT SHALL **DES** BE LIABLE FOR ANY CONSEQUENTIAL, CONTINGENT OR INCIDENTAL DAMAGES, OR THE DELAY IN PERFORMANCE OF THIS WARRANTY.

## Safety

---

Electrical rotating equipment and their associated controls can be hazardous if not handled properly. Please protect yourself by following a few precautions.

### **Disconnect battery leads before working on the controller.**

Lead acid batteries can supply very high currents and may explode if they are short circuited. Charging batteries generate hydrogen gas so exercise extreme caution whenever working near batteries. Follow the manufacturer's safety instructions. Always wear safety glasses and use properly insulated tools when working with batteries.

### **Always elevate the drive wheels when adjusting the controller**

An incorrect connection or adjustment could cause the vehicle to move unexpectedly. By raising the drive wheels off of the ground, you can prevent physical damage to yourself and the vehicle.

### **Keep your hands and clothing clear of rotating equipment**

## Q.C. Testing

---

Quality is an important factor of each phase of the manufacturing and development process. Each unit must pass rigorous quality tests prior to shipment. This assures that you receive only those controls that meet our demanding quality standards.

## Storage

---

Please take the following precautions if it should be necessary to store the **PACESETTER Plus** control for any length of time.



Store the control in a clean dry (non-corrosive) environment which is protected from sudden variations in temperature and high levels of moisture, shock and vibration.



The ambient temperature where the control is stored should be maintained between zero (0) and 65 degrees Centigrade.



The control should be stored in the original package in order to protect from dust and dirt contamination.



The control must be mounted in a location that is carefully chosen to keep the controller clean and dry. If a clean and dry location cannot be found, a case or cover must be used to protect the control from water and contaminants.



# Control Specifications

---

<b>SUPPLY VOLTAGE</b>	18 to 28 V continuous
<b>MINIMUM OPERATING VOLTAGE</b>	17 Volts
<b>NOMINAL CURRENT LIMIT</b>	70 Amperes
<b>CONTINUOUS CURRENT AT 25 DEGREES C</b>	35 Amperes
<b>MINIMUM BRAKE VOLTAGE</b>	B+ minus one volt
<b>MAXIMUM BRAKE CURRENT</b>	2 Amperes (current limited)
<b>PWM SWITCHING FREQUENCY</b>	18 KHZ (typical)
<b>AMBIENT OPERATING RANGE</b>	Zero to fifty Degrees C
<b>CONTROL POTENTIOMETER</b>	5 K Ohms (+/- 20%)
<b>ACCEL/DECEL RAMPS</b>	Adjustable from 0.2 to 2.0 seconds each.
<b>BRAKE DELAY</b>	One to three seconds (factory pre-set)
<b>REVERSE SPEED RANGE</b>	Adjustable from 0 - 100%

## Section Three

# Control Features

### Current Limit/ Temperature Foldback

---

The **PACESETTER Plus** incorporates sophisticated on-board current limiting with temperature foldback circuitry to protect the controller and equipment. The current limit is dynamic and will automatically adapt itself to the demands of the system while providing a safe current ceiling for protection.

This function will *roll back* the output signal to prevent damage to the controller in the event of prolonged periods of overload.

### Under Voltage Lockout

---

The **PACESETTER Plus** requires a minimum battery voltage of at least 18 volts before the control will enter an *enabled* state.

If the battery voltage drops below 17 volts, the output will be reduced by 50%. Should the battery voltage drop below 16.5 volts, the controller will shut down to protect the batteries.

### High Pedal Disable

---

The **PACESETTER Plus** contains safety circuitry which disables the output if the throttle is depressed before the key is turned on.

The output drive circuitry will remain in the disabled state until the throttle is released and the key is turned off and then back on again. This feature prevents unexpected movement of the vehicle.

## Accel And Decel Rates

---

The **PACESETTER Plus** contains a ramp generator which allows either symmetrical or asymmetrical rates for both acceleration and deceleration.

The acceleration and deceleration times are factory pre-set. Accel and Decel potentiometers allow independent adjustment of each parameter.

The acceleration and deceleration ramp times are adjustable from 0.2 seconds up to 2 seconds through the use of the **ACCEL** and **DECEL** potentiometers (R19 & R20).

The actual acceleration and deceleration times are dependant upon the characteristics of the vehicle and the load as well as other factors.

## Potentiometer Scaling

---

The **PACESETTER Plus** design allows the use of most conventional throttle potentiometers. Variations in potentiometer styles and rotation characteristics are pre-set at the factory or may be compensated for through the use of the input **GAIN** potentiometer.

Please refer to the setup procedure for the proper method for setting the **GAIN** potentiometer.

## Reverse Speed Limit

---

The **PACESETTER Plus** contains circuitry which will limit the reverse speed for safer operation in the reverse direction.

The reverse speed can be set from *zero* to *one hundred percent* of the forward speed, allowing customization for individual applications.

The **PACESETTER Plus** is equipped with a reverse speed limit potentiometer. The reverse speed can be set by adjusting, the **REV-SPD** potentiometer.

It is recommended that the reverse speed never be set higher than *sixty percent (60%)* of the forward speed. This level allows safe maneuverability and control in the reverse direction.

## Brake Timer And Driver

---

The **PACESETTER Plus** has an on-board timer and current limited brake driver circuit. This circuit may be used to control an external electromechanical brake.

This circuit is activated by the throttle, preventing premature application of the brake. The brake is not allowed to set until the throttle is in the neutral or center position and the deceleration ramp time has expired.

There is a short delay between the meeting of the above conditions and the actual setting of the brake. This delay will vary with the initial position of the throttle. This delay will be immediately reduced to zero in the event the vehicle begins to roll back during usage on an incline.

The brake delay is factory pre-set. This delay may be adjusted to compensate for varying applications. Please consult the factory with your specific requirements.

## Control Inhibit

---

The control inhibit circuit will disable the output of the control. This feature is convenient when you want the control to be disabled without disconnecting the power supply connections, such as when utilizing a battery charger.

The control may be disabled by applying either the positive or negative supply voltage to the INH terminal.

## Throttle Center Adjustment

---

A Throttle Center adjustment potentiometer is available which will allow the adjustment of the throttle potentiometer *zero* or *center* position.

Since no two throttle configurations are exactly the same, this feature has been provided to accommodate the mechanical variations in throttle potentiometer design.

The **CENTER** potentiometer when used in conjunction with the **GAIN** potentiometer will compensate for various throttle potentiometer configurations.

For adjustment information, please refer to the set-up procedure

## Single Ended Throttle Option

---

The PACESETTER Plus may be optionally configured for a single-ended throttle potentiometer. In this configuration, full counterclockwise is considered off. Two additional terminals are inserted in the FR+ and FR- positions. These terminals accept a switch or contact closure to change the direction of the motor.

For information on this configuration, please consult the factory.

## Pot Loss Protection

---

The **PACESETTER Plus** contains circuitry which constantly monitors the throttle potentiometer connections. If the throttle connections fail for any reason, the motor output will instantly be reduced to zero volts.

## Pot Out Of Range Protection

---

The **PACESETTER Plus** is also able to sense when the throttle potentiometer has traveled out of its normal operating range. This feature, if utilized, will monitor the throttle potentiometer to ensure that the pot wiper is never shorted to pot high or pot low. If the circuit ever detects a short, the motor output will instantly be reduced to zero volts.

This feature may become inoperative when a non-standard potentiometer with a custom resistive element configuration is used.

## Reverse Polarity Protection

---

Reverse polarity protection is provided to protect the control from damage caused by connecting the battery or low voltage power source with the polarities reversed.

If the connections to the battery or low voltage power source are ever reversed, the Power-On Relay will not operate. This protects the logic circuitry and prevents the controller from operating in an erratic manner.

## Anti-Plug Circuitry

---

The anti-plug circuit prevents instantaneous voltage reversal when reversing the direction of the motor.

When an instantaneous reverse command is issued, the control will quickly ramp the motor down to zero speed, reverse directions, and then ramp the motor back up to the set speed. This protects the motor from instantaneous voltage reversal which would cause damage to the motor.

## Four Quadrant Operation

---

Four-quadrant operation ensures that complete control is maintained over all phases of motor operation. Regenerative operation is fully controlled to provide quick braking and precise acceleration / deceleration control.

Four-quadrant operation also saves on battery power by regenerating the motor power back into the batteries

## Anti-Rollback

---

Under normal operation, the electro-magnetic brake output applies power to the brake whenever the throttle is moved from the off position (this is the center position for wig-wag style throttle pots and fully counterclockwise for single ended throttle pots). Brake power is removed after a short delay, whenever the throttle returns to the off position.

If the controller senses a change of direction after returning to the off position, the controller will immediately apply the brake without delay. In other words, if the vehicle is moving up an incline and the throttle is released, the brake will set immediately, preventing rollback.

# Section Four Installation

## Enclosure Considerations

The **PACESETTER Plus** has four (4) mounting holes for customer use.

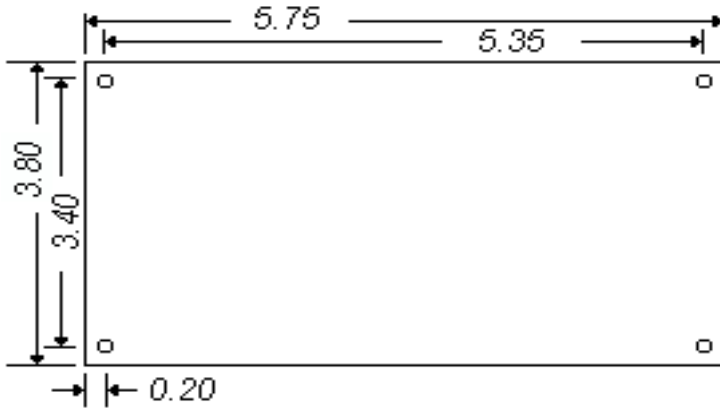

**The control must be mounted in a location that is carefully chosen to keep the controller clean and dry. If a clean and dry location cannot be provided, a case or cover must be used to protect the controller from water and contaminants. Failure to provide a clean dry environment will result in damage to the control and unpredictable performance.**

Ideally, the control should be mounted in a vertical position with the heatsink fins in the vertical position. This provides the optimal amount of airflow through the heatsink and across the power devices. If this mounting configuration is not possible, you may mount the control horizontally with the heatsink pointing up. Adequate free air movement should be provided for proper cooling. In addition, the ambient air temperature should be between zero and fifty (0-50) degrees Centigrade. Operation at higher ambient temperatures is possible, but the current capacity of the control will be reduced.

## Power Wiring

---

The **PACESETTER Plus** can deliver current in excess of eighty (80) Amperes during peak torque demand conditions. The continuous duty current rating of the controller is 35 Amperes.

The battery and motor lead wires should be capable of carrying 12 Amperes on a continuous duty basis. Motor and battery leads should also be kept as short as possible.

We recommend using wire no smaller than 12 Gauge wire for the battery and motor connections.

**WARNING:**

**APPLYING A VOLTAGE IN EXCESS OF 28 VOLTS TO B+ AND B- WILL RESULT IN PERMANENT DAMAGE TO THE CONTROLLER.**

## Signal Wiring

---

All additional wiring for the controller, the potentiometer, power on switch, inhibit switch and brake wiring should be capable of carrying three (3) Amperes of current on a continuous duty basis.

Generally, it is not necessary to use shielded cable for the potentiometer wiring unless erratic operation occurs.

To guard against electrostatic transients, it is recommended that the potentiometer bushing be grounded to **B-**.

## Terminal Descriptions

---

All customer control wiring should be connected to the **PACE-SETTER Plus** quick connect terminals. Standard male stab-on terminals (0.250") are used for all customer connections.

- B+ B-** These are the battery connections. Please note the proper polarity during installation. Two terminals are provided for each battery connection, allowing both the batteries and a charger to be connected.
- M+ M-** These are the motor connections. Please connect the motor accordingly so that a forward command causes the motor to spin in the proper direction.
- BK+ BK-** These are the electromechanical brake coil connections. The brake coil connected between these terminals will be activated when the motor operates, releasing the normally applied brake. An external switch connected between BK- and B- may be used to manually release the brake.
- SW** This is the controller ON/OFF switch connection. Closing a connection from SW to B+ will activate the controller.
- PH** This is the connection point for the high (leftmost) lead of the throttle potentiometer.
- PW** This is the connection point for the wiper (middle) lead of the throttle potentiometer.
- PL** This is the connection point for the low (rightmost) lead of the throttle potentiometer.

# Terminal Descriptions (continued)

---

- INH** Connecting this terminal to B+ or B- will inhibit the controller operation. This input is typically used to inhibit operation during battery charging.
- FR+ FR-** Optional terminals provided for single-ended throttle pot operation. When FR+ is shorted to FR- the motor will run in the forward direction.

# Typical Connection Diagram

---

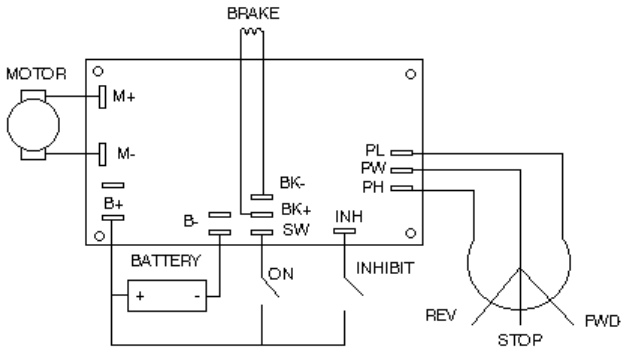

# Section Five

## Set-Up And Adjustment

### General Considerations

---

The **PACESETTER Plus** will typically be used with a spring centered 5 K Ohm potentiometer mechanism.

This configuration usually utilizes a small fraction of the total available swing for the operating range of the potentiometer. The **PACESETTER Plus** comes factory pre-set to accommodate most throttle configurations.

An optional input gain adjustment potentiometer is available to accommodate different throttle configurations which utilize varying degrees of potentiometer travel. Each configuration may be compensated for by adjusting the optional gain potentiometer.

Depending on the potentiometer configuration selected, only about 12 degrees of rotation in either direction from the zero position, are required to drive the control properly. This will allow the use of a 270 to 333 degree potentiometer to be used with varying degrees of swing.

If you intend to use a potentiometer, which has a shorter resistive element, please consult the factory for proper set-up.

## Speed Range Reduction Pot

It may be desirable to have a speed range reduction potentiometer in your system. This potentiometer can be used to adjust the maximum speed range of the main throttle potentiometer.

The speed range reduction potentiometer should be connected between the throttle potentiometer's wiper and the PW terminal on the controller as shown below.

Consult the graph below to select the value according to the amount of speed reduction desired.

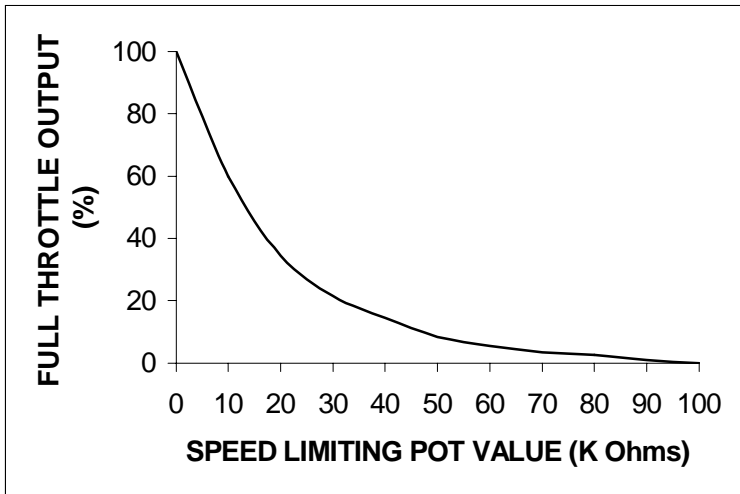
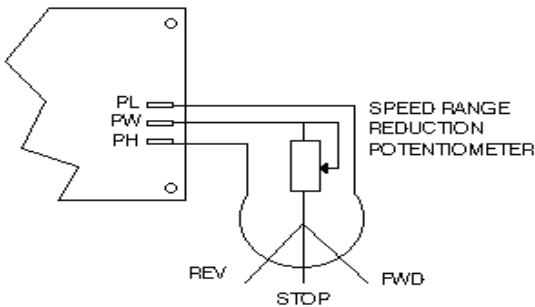

Effects of Speed Reduction Pot Value

# Set-Up Procedure

---

1. Raise the wheels of the vehicle and disconnect the power supply. Mount the control in the vehicle and connect the terminals as follows:



Connect the 24 volt power supply to terminals **B+** and **B-** noting proper polarity.



Connect the drive motor to terminals **M+** and **M-** so that when a forward command is issued, the motor will spin in the forward direction.



Connect the parking brake coil to terminals **BK+** and **BK-** noting proper polarity.



Connect the power switch from the positive battery lead to the **SW** terminal.



Connect the inhibit line (if used) from the positive or negative battery lead to the **INH** terminal.



Connect the throttle potentiometer High, Wiper, and Low leads to the corresponding **PH**, **PW**, and **PL** terminals.

## Set-Up Procedure (continued)

---

If your controller is fitted with the optional adjustment pots...

2. Preset the optional controller adjustment potentiometers as follows:



**CENTER** potentiometer to mid position.



**GAIN** potentiometer fully *clockwise*. This sets the gain to minimum.



**DECEL** and **ACCEL** potentiometers full *clockwise*. This sets the ramps to their fastest rates.



**REV-SPD** potentiometer full *clockwise*. This sets the reverse speed to maximum (equal to forward speed).



If the vehicle is equipped with an optional speed reduction potentiometer, set this potentiometer for maximum speed.

3. Connect power to the control and turn the power switch on. Apply a full forward throttle. With the throttle at full forward, slowly turn the **GAIN** potentiometer *counterclockwise* until the motor is running at the desired full forward speed.

**WARNING:**

**IF THE GAIN POTENTIOMETER IS TURNED TOO FAR IN THE COUNTERCLOCKWISE DIRECTION, THE MOTOR WILL STOP ABRUPTLY. TURN THE GAIN POT SLIGHTLY CLOCKWISE, RELEASE THE THROTTLE AND CONTINUE.**

## Set-Up Procedure (continued)

---

4. Release the throttle potentiometer and allow it to return to the zero speed position. Adjust the **CENTER** potentiometer until the motor is stopped at the throttle zero position. Verify that the operation of the throttle potentiometer is symmetrical in the forward and reverse directions. Repeat step 3 to verify full forward speed is attained.
5. Apply a full reverse throttle. With the throttle applied, adjust the **REV-SPD** potentiometer until the motor is running at the desired reverse speed.
6. If the vehicle is equipped with a maximum speed reduction potentiometer, set it for minimum speed. Check the balance between forward and reverse speed. Adjust the **CENTER** potentiometer, if necessary, to achieve symmetrical operation. Return the maximum speed reduction potentiometer to its maximum speed position.
7. Adjust the **ACCEL** potentiometer to the desired rate of acceleration. Adjust the **DECEL** potentiometer to the desired rate of deceleration. Lower the vehicle until the wheels are on the ground and verify that the desired rate of acceleration and deceleration has been achieved. Re-adjust as necessary.

**CHANGING THE ACCEL POTENTIOMETER SETTING MAY CHANGE THE DECELERATION RATE SLIGHTLY. ALWAYS ADJUST THE ACCEL POTENTIOMETER BEFORE ADJUSTING THE DECEL POTENTIOMETER.**

**THIS CONCLUDES THE SET-UP PROCEDURE**

## Section Six

# Troubleshooting

<b>PROBLEM</b>	<b>PROBABLE CAUSE</b>	<b>CORRECTIVE ACTION</b>
Vehicle does not move when a throttle signal is applied	ON/OFF switch is not closed	Check the ON/OFF switch connections. Ensure that B+ is connected to the SW terminal
	Battery connections are reversed	Check the battery connections. Ensure that the positive battery terminal is connected to B+ and the negative battery terminal is connected to B-
	GAIN pot is mis-adjusted	Turn the GAIN pot slightly clockwise and re-apply throttle
	Controller is inhibited	Check to make sure that the INH terminal is not connected to B+ or B-
Vehicle stops abruptly when maximum throttle is applied	GAIN pot is mis-adjusted	Turn the GAIN pot slightly clockwise and re-apply throttle
	Faulty throttle connections	Verify that all throttle connections are securely connected to the throttle pot and the PH,PW and PL terminals
Little or no reverse speed	REV-SPD pot is set too low	Turn the REV-SPD pot clockwise and re-check reverse speed
	CENTER pot is misadjusted	Re-adjust the CENTER pot according to the set-up instructions