



SPECIFICATIONS - 4808SRF

Totally Automatic Switch-Mode Battery Chargers

"Suitable for Gel, Sealed & Wet Lead Acid Batteries"

Summary: **48 V, 4Amp Constant Current**
(equivalent to 8A tapered charger in charging time)

- Automatic Cut-off and then true Float. Can be left connected indefinitely without harming the battery.
- **UL , CSA, TUV, GS, European Standard EN60335 Part 2.29 and CE European EMC Directive) Listed.**
- **Input 115/230 VAC**
- Suitable for U.S., Canada, Japan, Europe.
- Suitable for On-board (internal) & Off-board (external) Applications.
- Increases battery life by **de-sulfating the battery**.
- Many advance features described in this spec.
- **Very small size and very light weight.**

Explanation of the Features:

The advance technology of the OEM Battery Chargers supplied by Soneil is fundamentally different from other battery chargers. The conventional linear battery charger is an electrical device whereas the 4808SRF is a light weight sophisticated electronic device.

1. Switch-Mode Technology:

Most of the battery chargers use linear technology, which convert the 115/230 VAC to 48 VDC at 60/50 Hz. This requires a large transformer, which has the disadvantage of lower efficiency resulting in higher heat generation, larger size and weight.

Soneil's Battery Charger transforms the 115/230 VAC into 48 VDC at 100,000 Hz (3333 times faster than conventional charger), which requires a much smaller transformer and this results in a unit of smaller size, low weight and improved efficiency.

The 4808SRF uses sophisticated electronic circuitry with microchip. All present day computers use switch-mode technology.

2. **International Safety Approvals & Listing:**

UL, CSA (ULc), TUV, GS, KEMA, European Standard EN60335 Part 2.29 and CE (European EMC Directive) approvals in a single charger.

3. **Input Requirements:** Dual Voltage - Switch selectable

- a) 115 VAC (range 90 - 130 VAC) or
230 VAC (range 180 - 260 VAC)
- b) 47 - 63 Hz

Input AC tolerance +/- 20%. This means 4808SRF will operate satisfactorily in areas where the input voltage is low.

This charger is also **suitable for every part of the world** including **Japan** where input is 100 VAC.

4. **Output:**

4 Amps Constant Current @ 48 Volts DC
(Equivalent to 8 Amps tapered in charging time)

- a) Line Regulation @ Full Load 2%
- b) Load Regulation @ 115/230 VAC 3%

c) **Ripple Voltage:** Very low

The peak to peak ripple voltage into a resistive load is less than 200mV for the output voltage above 48 VDC.

5. **Charging Cycle:**

The charging curve is attached. The explanation of the charging cycle is as following.

a) **AC connected and battery not connected:**

When the charger is connected to the AC power, the red light will be ON, showing that AC power is connected. If the output is not connected to the battery, the green light will flash informing the user that battery side is not connected. Some of the scooter users may be old and if they forget to connect the battery side, the green flashing light reminds them.

b) **Charging:**

The charging curve is attached. The explanation of the charging cycle is as following.

Stages	Condition	Mode*	Current	Voltage	LED Indication
Stage 1	Constant Current mode	CC mode	Constant 4A	To 57.6V	Yellow
Stage 2	Constant Voltage mode	CV mode Cell voltage equalization	Reduces from 4A***	Holds at 57.6V	Yellow
Stage 3	Float Voltage mode	Float CV mode	Reduces to zero	Maintains 55.2V	Green
Stage 4	Recharging mode	CC mode	4A	55.2V	Yellow

* CC mode = Constant current charge

* CV mode = Constant voltage charge

*** See stage description below

Stage 1: Constant Current Mode (CC): LED Yellow

The charging is at constant current (4A). When the battery voltage reaches up to 57.6V, the charger changes from CC (Constant Current) to CV (Constant Voltage) mode.

Stage 2: Cell voltage equalization; Constant Voltage Mode (CV): LED Yellow

The charger holds the battery at 57.6V and the current slowly reduces. When the current reaches at 0.5CC (CC = Constant current), this point called the Switching Point. The Switching Point is one of the great feature of this battery charger that it can adjust the current automatically according to battery capacity. Other chargers are not capable to adjust the current automatically.

Stage 3: Float Voltage Mode: LED Green

The charger maintains the battery voltage at 55.2V and current slowly reduces to zero. Charger can be left connected indefinitely without harming the battery.

Stage 4: Recharging: LED Yellow

If the battery voltage drops down to 55.2V, the charger changes from any mode to Constant Current mode and restart charging. The charging cycle will go through Stage 1 to Stage 3.

Soneil charger can charge gel, sealed or wet lead acid batteries without use of any switch.

6. Two colours in one LED:

LEDs are used to show the charging status. The Red LED shows AC on. The second bicolour LED shows Yellow when charging and changes to Green when the battery is fully charged. The charger will continue to provide very small current to cover internal losses and will maintain the battery at full charge.

7. Very low voltage start: 0.5 Volts

Will charge very deeply discharged batteries. Many 48 volts chargers in the market will not charge batteries discharge below 24 volts.

8. Protection:

User accessible input (AC) and output fuses are provided.

- a) **Reverse polarity protection** - provided
- b) **Short circuit protection** - provided
- c) **Over-Voltage Protection** - provided
- d) **Over current protection** - provided
- e) **AC Surge Protection** - provided
- f) **Power on-off switch** - provided
- g) **Soft start and stop:** Starts and stops gradually.

No sudden in-rush of current. This protects both the batteries and any other circuits connected to the charger.

9. **De-sulfation of battery:** The charger will remove loose sulfation and increase the battery life. (Hard sulfation cannot be reversed).
10. **No current drain:**
No (zero) current is taken from the battery when connected to battery but AC not plugged in. (Many other chargers in the market draw 30-40 mA, which drains the battery.)
11. **Reliability:**
 - a) **Mean Time between failures (MTBF):**
30,000 power-on-hours (POH) or greater. This translates into 10 years of everyday operation of 8 hours.
 - b) **Burn-in:** All chargers are burned in at an average DC load of 4 Amps.
12. **Electromagnetic Interference (EMI):**

The charger will not generate excessive radiated or conducted emissions. No interference with TV, radio, computer or other equipment.

The charger is in compliance with CE (European EMC Directive). . Meets EN55022, EN50081-1& -2, EN60555 -2 & -3, EN 50082 -1, IEC 801 -2, -3 & -4.
13. **Ground leakage current:**

The ground leakage current is 87 microAmp, which complies with the requirements.
14. **On-board Feature:** Option

The model has a third output wire which provides an inhibit signal that will prohibit the operation of the vehicle's motor controller whenever the charger is plugged to an AC source.

Inhibit signal: The inhibit signal is an open circuit output, leakage less than 5 microAmp or less, when the charger is not connected to an AC source. This signal

will be less than 50 mV DC while sinking 10 mA when the charger is connected to an AC source.

15. **Size:** **Very Small** Length - 6.9" (175 mm)
Width - 3.7" (94 mm)
Height - 1.9" (48 mm)

Very Light Weight 1.7 lbs. (750 grams)

Very nice looking **metal case with black matte finish.**

Ref: 4808SRF.052501

CHARGING CURVE MODEL 4808SRF

SONEIL 48V/4A CHARGER
(4A CONSTANT CURRENT)

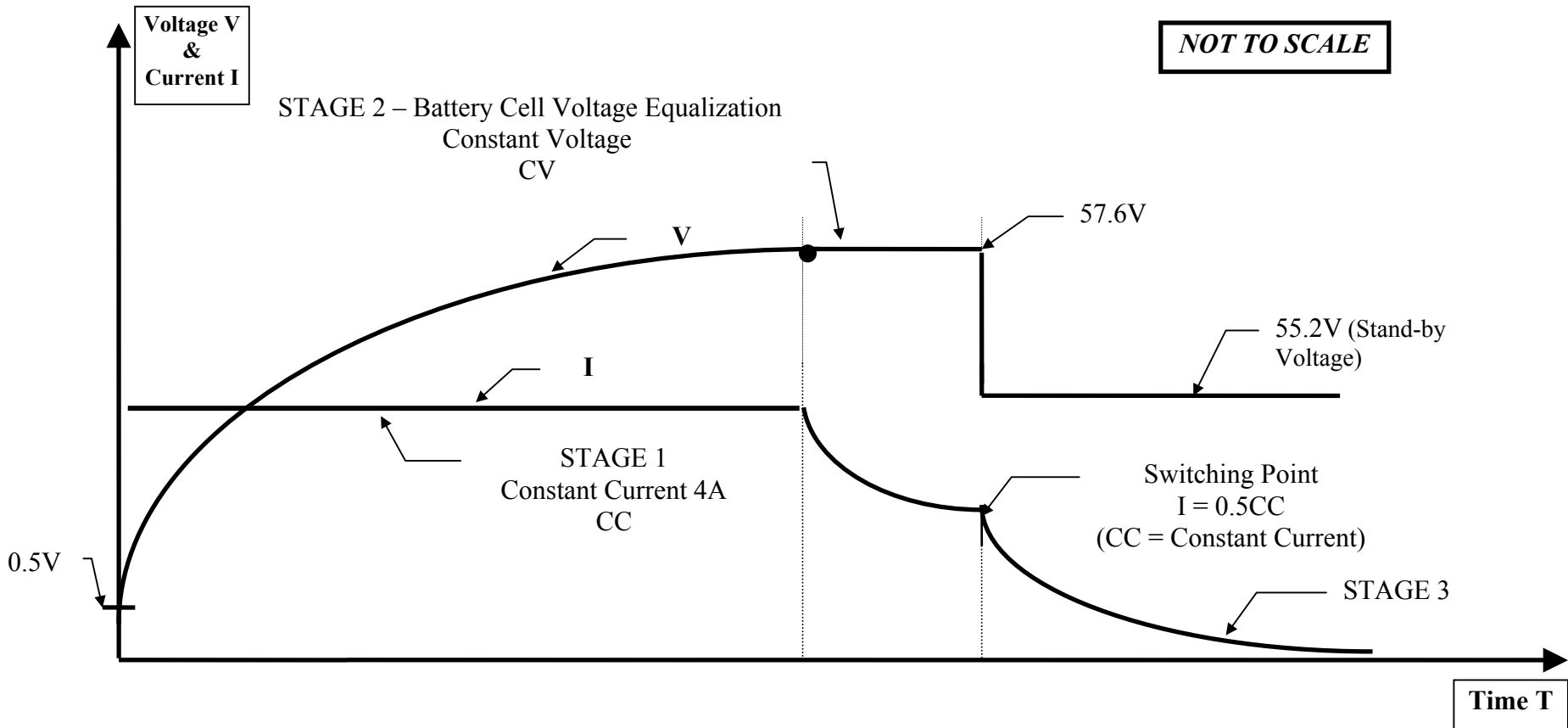

506-2412-R1X

OUTPUT CONNECTOR:(TYPE SEE REMARK1)

TYPE: STD

PRINTED: +VE
NO PRINT: -VE

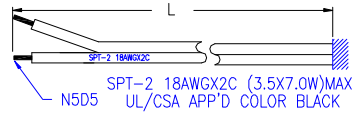

TYPE: A

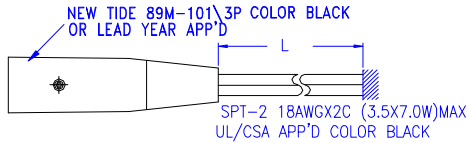
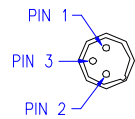

TYPE: B

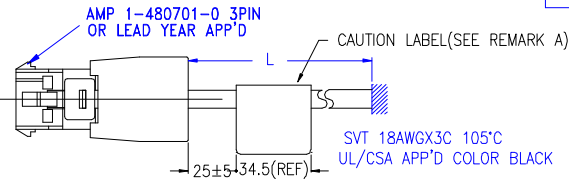
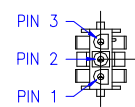

TYPE: C

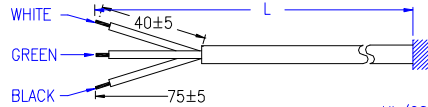

REMARK A:

P/N	TYPE	MODEL NAME	WIRING	L (WIRE LENGTH)	CAUTION LABEL	REMARK
506-2412-R11	STD	2412SRF-C	PRINTED: +VE NO PRINT: -VE	1500±50	N/A	NOT 3P HEAD
506-2412-R12	A	2412SRF-B	PIN 1 : +VE PIN 2 : -VE PIN 3 : JUMPER FROM PIN2	1450±50	N/A	3P CONNECTOR
506-2412-R14	B	2412SRF-B	PIN 1 : -VE PIN 2 : INHIBIT PIN 3 : +VE	265±10	YES	AMP 1-480701-0 3P CONNECTOR
506-2412-R15	C	2412SRF-B	BLACK : -VE GREEN : INHIBIT WHITE : +VE	315±10	N/A	

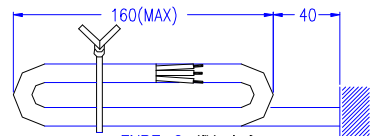

TYPE C 綁線方式

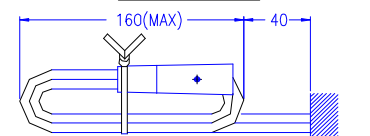

TYPE A 綁線方式

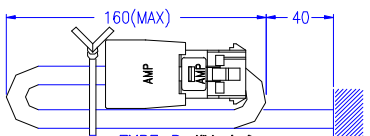

TYPE B 綁線方式

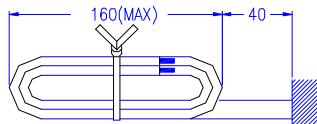

TYPE: STD 綁線方式

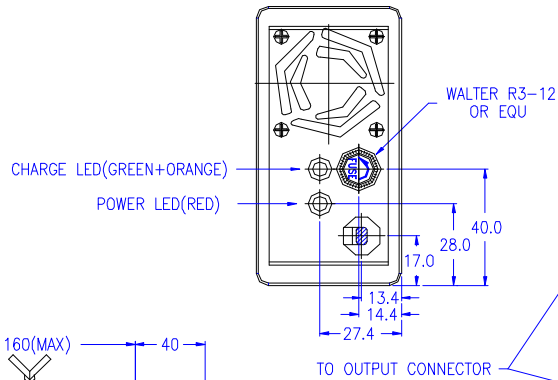

TO OUTPUT CONNECTOR

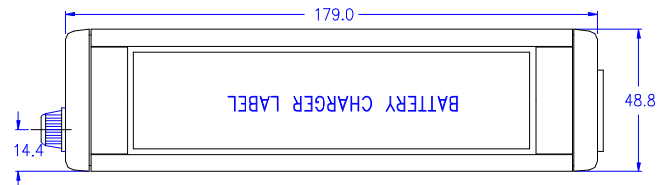

IN ALWAYS 0717-1(-S) OR EQU

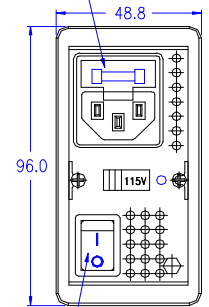
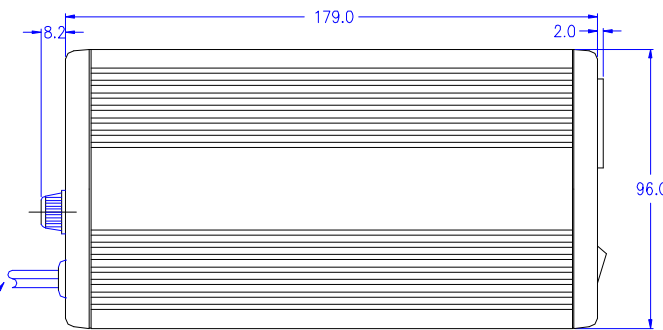

SOLTEAM MR21 OR EQU



FILE:2412\OUTLINE

ISSUE

SONEIL - MISSISSAUGA CANADA
ONTARIO

UNIT mm SCALE SHEET 1 OF 1 R O C

TOLERANCE: X ±0.3 X ±1.0
UNLESS OTHERWISE SPECIFIED XXX ±0.05 XX ±0.3

DRAWN DESIGNED CHECKED APP'VD DATE
JUL.31.2001

506-2412-R1X

TITLE X=B OR C

2412SRF-X1